

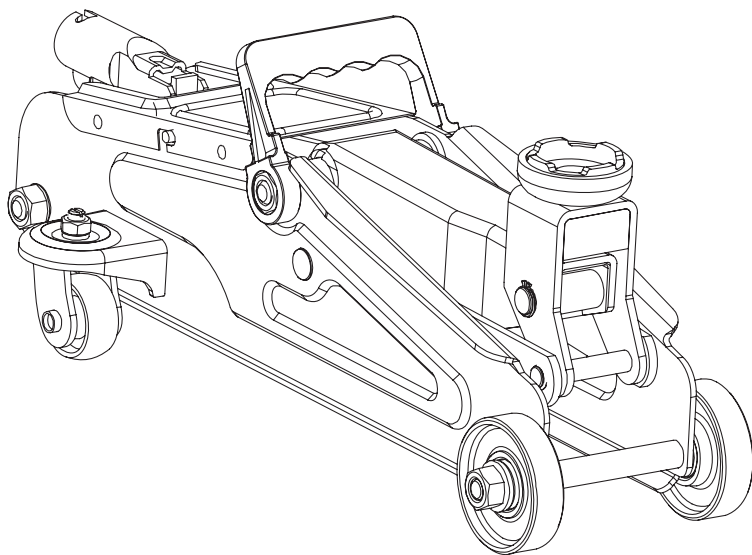

OWNER'S MANUAL

2 TON HYDRAULIC TROLLEY JACK

Item: T82002



▲ WARNING!

Questions, problems, missing parts? Before returning to your retailer, call our customer service department at 1-888-44-TORIN (1-888-448-6746), 8 a.m. - 5 p.m., PST, Monday-Friday.

Read carefully and understand all ASSEMBLY AND OPERATION INSTRUCTIONS before operating. Failure to follow the safety rules and other basic safety precautions may result in serious personal injury.

IMPORTANT

Before You Begin Register This Product.

For future reference, record the model name, model number, date of manufacture and purchase date of this product. You can find this information on the product.

Model Name _____

Model Number _____

Date of Manufacture _____

Date of Purchase _____

OWNER / USER RESPONSIBILITY

DO NOT OPERATE OR REPAIR THIS PRODUCT WITHOUT READING THIS MANUAL.

Read and follow the safety instructions. Keep Instructions readily available for operators. Make certain all operators are properly trained and understand how to safely and correctly operate the product. By proceeding you agree that you fully understand and comprehend the full contents of this manual. Failure to operate this product as intended may cause injury or death. The manufacturer is not responsible for any damages or injury caused by improper use or neglect. Allow product operation only with all parts in place and operating safely. Use only genuine replacement parts. Service and maintain the product only with authorized or approved replacement parts; negligence will make the product unsafe for use and will void the warranty. Carefully inspect the product on a regular basis and perform all maintenance as required. Store these instructions in a protected dry location. Keep all decals on the product clean and visible. Do not modify and/or use for any application other than that for which this product was designed. If you have any questions relative to a particular application, DO NOT use the product until you have first contacted the distributor or manufacturer to determine if it can or should be performed on the product.

For technical questions please call 1-888-448-6746.

INTENDED USE

This trolley jack has a single hydraulic pump piston that effortlessly raises the lift arm. Pump piston dust shields and wiper seals protect the hydraulic system from contaminants. The jack features an overload valve bypass system to prevent jack damage and user injury. Compact design allows use in confined spaces. Easily fits under low vehicles. Meets ASME PASE safety standards.

TECHNICAL SPECIFICATIONS

Item	Capacity	Lifting Range Min. (Inch)	Lifting Range Max. (Inch)	Lifting Range Min. (cm)	Lifting Range Max. (cm)
T82002	2 TON	5-1/4	13-3/8	14	34

GENERAL SAFETY RULES

- ⚠ WARNING:** Read and understand all instructions. Failure to follow all instructions listed below may result in serious injury.
- ⚠ CAUTION:** Do not allow persons to operate or assemble this jack until they have read this manual and have developed a thorough understanding of how the jack works.
- ⚠ WARNING:** The warnings, cautions, and instructions discussed in this instruction manual cannot cover all possible conditions or situations that could occur. It must be understood by the operator that common sense and caution are factors that cannot be built into this product, but must be supplied by the operator.

GENERAL SAFETY RULES IMPORTANT SAFETY CONSIDERATIONS

INSPECTION

- Inspect the jack carefully before each use. Ensure the jack is not damaged, excessively worn, or missing parts.
- Do not use the jack unless it is properly lubricated.
- Using a jack that is not in good clean working condition or properly lubricated may cause serious injury.
- Inspect the work area before each use. Make sure it is free and clear of any potential hazards.

DO NOT OPERATE OR REPAIR THIS EQUIPMENT WITHOUT READING THIS MANUAL.

To maintain the Service Jack and user safety, the responsibility of the owner is to read and follow these instructions.

- Inspect the service jack for proper operation and function.
- Keep instructions readily available for equipment operators.
- Make certain all equipment operators are properly trained; understand how to safely and correctly operate the unit.
- Allow unit operation only with all parts in place and operating properly.
- Use only genuine replacement parts.
- Service and maintain the unit only with authorized or approved replacement parts; negligence will make the jack unsafe for use and void the warranty.
- Carefully inspect the unit on a regular basis and perform all maintenance as required.
- Store these instructions in the handle of your jack.
- Keep all decals on the unit clean and visible.

SAFETY

Always follow safety precautions when installing and operating this jack. Keep all decals on the unit clean and visible. Before proceeding ensure that you fully understand and comprehend the full contents of this manual. Failure to operate this equipment as directed may cause injury or death. The distributor is not responsible for any damages or injury caused by improper use or neglect.

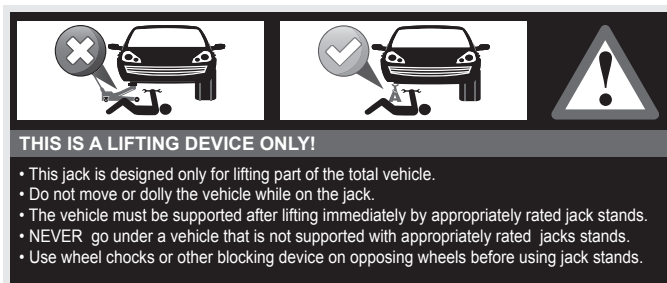

⚠ WARNING!

Always use Jack Stands!

DO NOT USE wood blocks or any other non-approved load sustaining devices. The manufacturer only warrants loads to be sustained by jack stands that meet current ASME standards.

DO NOT USE wood blocks or any other non-approved lifting devices for a means of lifting with the jack and/or load being raised. Failure to heed these warnings may cause injury or death.

SAFETY MARKINGS

⚠ WARNING!

1. Study, understand, and follow all instructions before operating this device.
2. Do not exceed rated capacity.
3. Use only on hard, level surfaces, with less than 3 degrees of slope.
4. Lifting device only. Immediately after lifting, support the vehicle with appropriate means.
5. Do not move or dolly the vehicle while on the jack.
6. Lift only on areas of the vehicle as specified by the vehicle manufacturer.
7. No alterations shall be made to this product.
8. Only attachments and/or adapters supplied by the manufacturer shall be used.
9. Do not get under or allow anyone under the vehicle until it has been supported by jack stands.
10. Center load on saddle prior to lifting.
11. Use wheel chocks or other blocking device on opposing wheels before using jack.
12. Never use on a lawn mower or lawn tractor.
13. Do not use this jack for any use other than the manufacturer specified usage.
14. Do not rock the vehicle while working on or around equipment.
15. The following are not recommended for supporting on this equipment: Foundations, Homes, Mobile Homes, Trailers, RV's, Campers, nor Fifth Wheels, etc...
16. Failure to heed these markings may result in personal injury and/or property damage.

GENERAL SAFETY INSTRUCTIONS

Position the Jack

Position the jack to only lift on the areas of the vehicle as specified by the vehicle manufacturer.

Always Use Jack Stands

After lifting the vehicle always support the load with appropriately rated vehicle Jacks stands before working on the vehicle.

Do Not Overload Jack

Do not overload this jack beyond its rated capacity. Overloading this jack beyond its rated capacity can cause damage to or failure of the jack.

Always Use on Hard Level Surfaces

This jack is designed only for use on hard level surfaces capable of sustaining the load. Use on unstable or other possible loss of load.

Chock and Block (Stabilize)

Apply parking brake in vehicle before operating jack.

A chock is a wedge for steadying an object and holding it motionless, or for preventing the movement of a wheel Chock the wheel opposite the end being lifted.

When you block a load, you secure and support a load that is being lifted. The block(s) or stabilizer(s) should have a weight capacity that is greater than the weight of the load which is being lifted.

Center Load on Jack Saddle

Center load on jack saddle before lifting vehicle.

Off-center loads and loads lifted when the jack is not level can cause loss of load or damage to the jack.

Do not raise or lower the vehicle unless tools, materials and people are clear.

When the lift is being lowered, make sure everyone is standing at least six feet away. Be sure there are no tools or equipment left under or around the jack before lowering.

Always lower the jack slowly.

DO NOT USE THE JACK TO SUPPORT OR STABILIZE A LOAD.

Using the jack to support or stabilize a load may result in unexpected movement and result in serious injury, being crushed and death. Always securely chock and block (stabilize) the load to be lifted. Never place any part of the body under a raised load without properly chocking and supporting the load.

Never use the jack on curved or tubular vehicle

Bumpers, this will result in the vehicle slipping off the jack and falling, causing serious injury or death. Use a bumper lift to lift most vehicles with curved bumpers or plastic bumpers.

Wear ANSI-approved safety glasses and heavy-duty work gloves during use.

Do not adjust the safety valve.

Do not move or dolly vehicle while jack is in use.

Stay alert. Use caution and common sense when operating jack. Do not use a jack when tired, incoherent, dizzy, under the use of drugs or alcohol.

Training

Read this manual before use. Do not allow anyone who has not read this manual, and/or does not understand the requirements, to use the jack.

Spectators

Do not allow bystanders around the jack or under the load supported only by the jack. -Do not allow anyone in the vehicle while the jack is in use. Keep all bystanders away from vehicle when in use.

Inspection

Inspect the jack carefully before each use. Ensure the jack is not damaged, excessively worn, or missing parts. -Do not use the jack unless it is properly lubricated. -Using a jack that is not in good clean working condition or properly lubricated may cause serious injury.

Additional Notes:

Save the receipt, warranty and these instructions.

Do not modify the jack in any way. Unauthorized modification may impair the function and/or safety and could affect the life of the equipment. There are specific applications for which the jack was designed.

Always check for damaged or worn out parts before using the jack. Broken parts will affect the equipment operation. Replace or repair damaged or worn parts immediately.

When jack is not in use, store it in a secure place out of the reach of children. Inspect it for good working condition prior to storage and before re-use.

ASSEMBLY

1. Familiarize yourself with the jack.

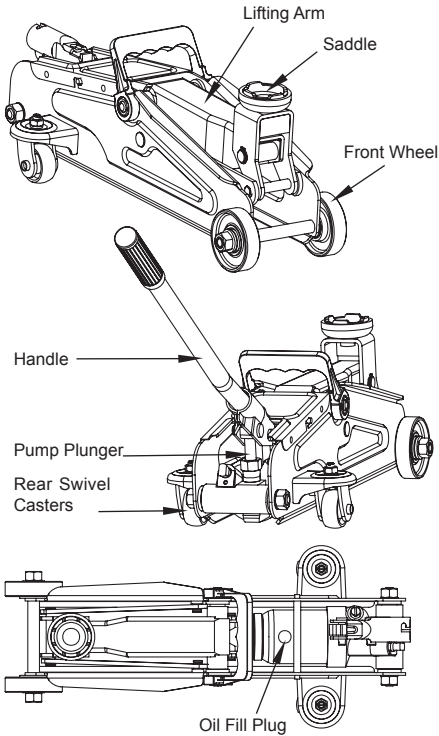

3. Secure the handle in place inside the handle socket. Without any vehicle on the jack. Cycle the lift up and down several times to insure the hydraulic system is operating properly. (Perform to the Air Purge Procedure before first use.)

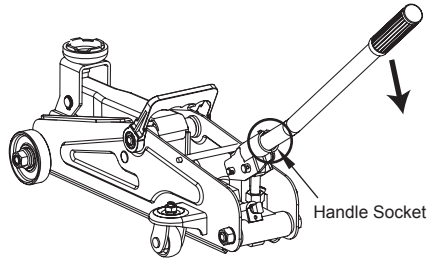

2. Line up the bottom of handle to the release valve located under the handle socket. Turn handle and release valve Clockwise to Tighten.

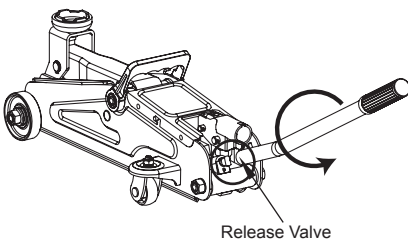
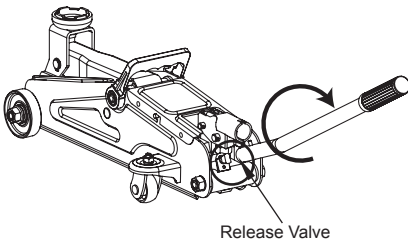

SYSTEM AIR PURGE PROCEDURE

IMPORTANT: BEFORE FIRST USE

Perform the following Air Purge Procedure to remove any air that may have been introduced into the hydraulic system as a result of product shipment and handling. This step is to be completed without any weight on the jack.

1. Turn release valve counterclockwise one full turn to the open position.

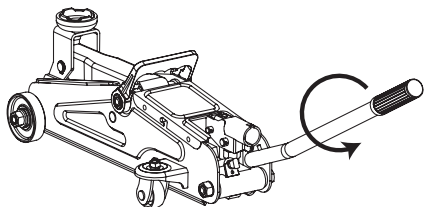

2. Remove cover plate.

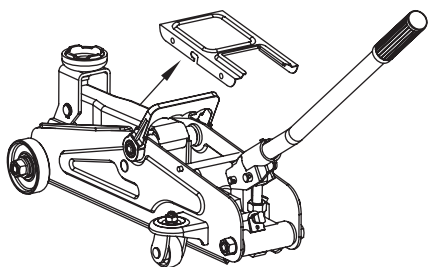

3. Rapidly pump the handle 6-8 times. Leave handle in down position to expose oil fill plug.

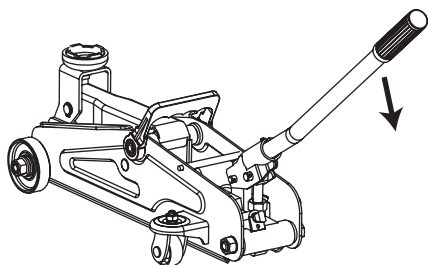

4. With a flat blade screwdriver, push the oil fill plug slightly to the side to purge trapped air from system. (Use caution not to tear or puncture the oil plug.)

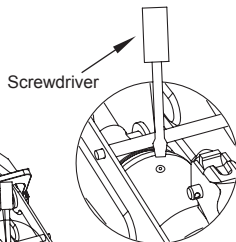

5. Replace cover plate and the jack is now ready for use. Check for proper pump action.

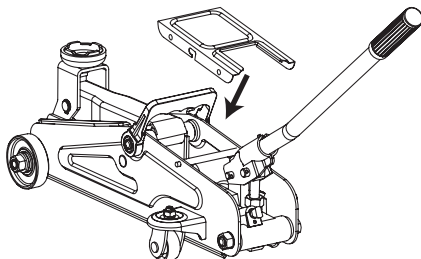

6. Turn release valve clockwise to the closed position.

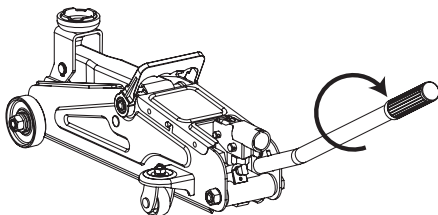

7. Jack is now ready for use. Check for proper pump action. (Repeat steps if necessary).

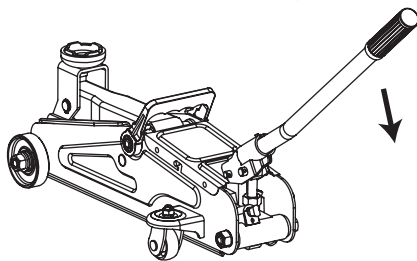

BEFORE USE

1. Before using this product, read the owner's manual completely and familiarize yourself thoroughly with the product and the hazards associated with its improper use.
2. Perform the air purge procedure. (See System Purge Procedure.)
3. Check and that the pump operates smoothly before putting into service.
4. Inspect before each use. Do not use if bent, broken or cracked components are noted.

OPERATION

RAISING THE JACK

1. Block the vehicle's wheels for lifting stability. Secure the load to prevent inadvertent shifting and movement
2. Position the jack near desired lift point.
3. Set the Parking Brake in the vehicle.
4. Refer to the vehicle manufacturer owner's manual to locate approved lifting points on the vehicle. Position the jack so that the saddle is centered and will contact the load lifting point firmly.
5. Assemble the handle; ensure to align with slots.
6. Close the release valve by turning it clockwise until it is firmly closed.

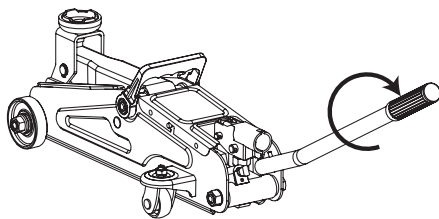

7. Before raising the vehicle double check and verify the saddle is centered and also has full contact with the lifting point.
8. Pump handle to lift until saddle contacts load. Continue to pump the jack handle to lift the vehicle to the desired height. After lifting, support the load with appropriately rated vehicle support stands before working on the vehicle.

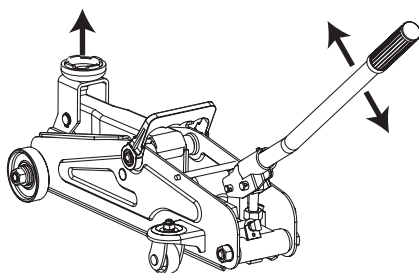

⚠ CAUTION: NEVER WIRE, CLAMP OR OTHERWISE DISABLE THE LIFT CONTROL VALVE TO FUNCTION BY ANY MEANS OTHER THAN BY USING THE OPERATOR'S HAND. USE THE HANDLE PROVIDED WITH THIS PRODUCT OR AN AUTHORIZED REPLACEMENT HANDLE TO ENSURE PROPER RELEASE VALVE OPERATION. DO NOT USE EXTENSIONS ON THE OPERATING HANDLE.

LOWERING THE JACK

1. Raise load high enough to allow clearance for the jack stands to be removed, then carefully remove jack stands.

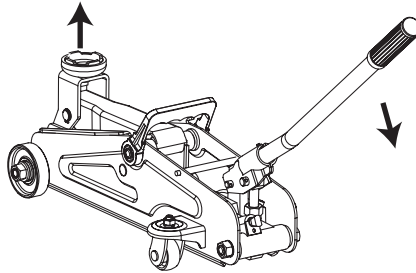

2. Remove support stands.

3. Grasp the handle firmly with both hands. Securely hold on to the jack handle so your hands do not slip and ensure the release valve does not rapidly lower.

4. Carefully open the Release Valve by slowly turning the handle counter-clockwise. (Do not allow bystanders around the jack or under the load when lowering the jack.)

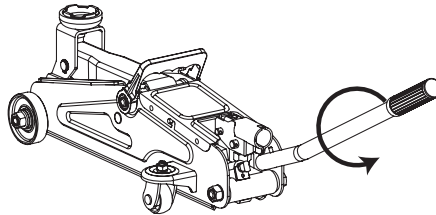

5. After removing jack from under the load, keep jack in the lowered position to reduce exposure to rust and contamination.

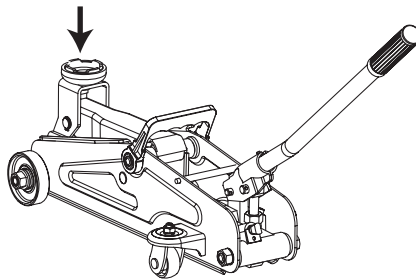

⚠ WARNING: WARNING: USE EXTREME CAUTION WHEN LOWERING THE JACK. THE JACK HANDLE MAY TURN RAPIDLY. OPENING THE RELEASE VALVE TOO FAST CAN CAUSE THE JACK TO LOWER RAPIDLY. FAILURE TO HEED THESE WARNINGS COULD CAUSE SERIOUS INJURY OR DEATH.

MAINTENANCE INSTRUCTIONS

If you use and maintain your equipment properly, it will give you many years of service. Follow the maintenance instructions carefully to keep your equipment in good working condition. Never perform any maintenance on the equipment while it is under a load.

Inspection

You should inspect the product for damage, wear, broken or missing parts (e.g.: pins) and that all components function before each use. Follow lubrication and storage instructions for optimum product performance.

Binding

If the product binds while under a load, use equipment with equal or a larger load capacity to lower the load safely to the ground. After un-binding; clean, lubricate and test that equipment is working properly. Rusty components, dirt, or worn parts can be causes of binding. Clean and lubricate the equipment as indicated in the lubrication section. Test the equipment by lifting without a load. If the binding continues contact Customer Service.

Cleaning

If the moving parts of the equipment are obstructed, use cleaning solvent or another good degreaser to clean the equipment. Remove any existing rust, with a penetrating lubricant.

Lubrication

This equipment will not operate safely without proper lubrication. Using the equipment without proper lubrication will result in poor performance and damage to the equipment. Some parts in this equipment are not self-lubricating inspect the equipment before use and lubricate when necessary. After cleaning, lubricate the equipment using light penetrating oil, lubricating spray.

- Use a good lubricant on all moving parts.
- For light duty use lubrication once a month.
- For heavy and constant use lubrication recommended every week.
- NEVER USE SANDPAPER OR ABRASIVE MATERIAL ON THESE SURFACES!

Rust Prevention:

Check rams and pump plungers on the power unit assemblies daily for any signs of rust or corrosion. Without a load lift the equipment as high as it goes and look under and behind the lifting points. If signs of rust are visible clean as needed.

Grease Fittings

Some models contain grease fittings the will regularly need to be greased and lubricated.

How the Jack Operates

With release valve closed, an upward stroke of the jack handle draws oil from the reservoir tank into the plunger cavity. Hydraulic pressure holds the valve closed, which keeps the oil in the plunger cavity. A downward stroke of the jack handle releases oil into the cylinder, which forces the ram out. This raises the saddle. When the ram reaches maximum extension, oil is bypassed back into the reservoir to prevent an over extended ram stroke and possible damage to the jack. Opening the release valve allows oil to flow back into reservoir. This releases hydraulic pressure on the ram, which results in lowering the saddle.

Storing the Jack

1. Lower the Lifting Arm.
2. Place the handle in the upright position.
3. Store in a dry location, recommended indoors.

Note: If the jack is stored outdoors, be sure to lubricate all parts before and after use to ensure the jack stays in good working condition. Always store jack in the fully retracted position when stored in outdoor or caustic environments that can cause corrosion and/or rust.

TO ADD JACK OIL

1. Position the jack on level ground and lower the saddle.

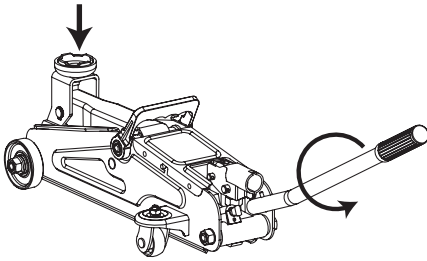

2. Remove cover plate.

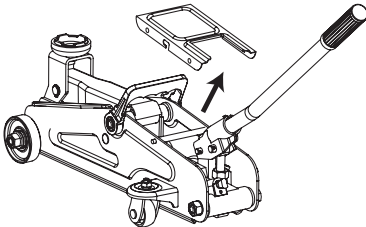

3. Remove the oil plug.

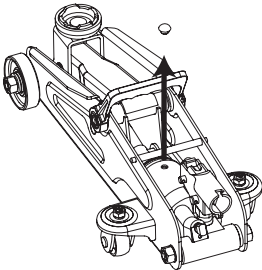

4. Fill the oil case until oil level is just beneath the lower rim of the oil fill hole.

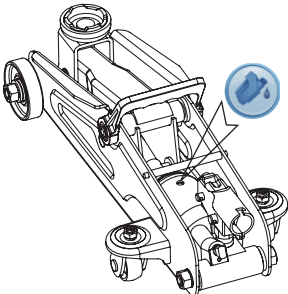

5. Replace oil plug.

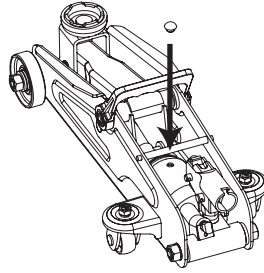

6. Replace coverplate and perform the Air Purge Procedure.

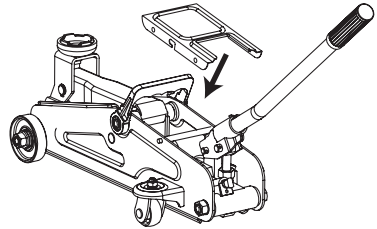

TO REPLACE JACK OIL

1. Position the jack on level ground and lower the saddle.

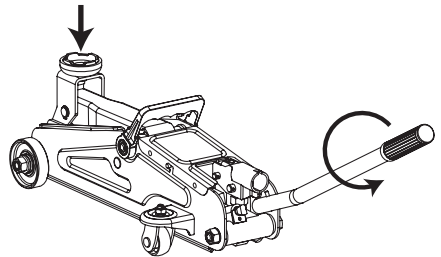

2. Open release valve by turning handle counter-clockwise.

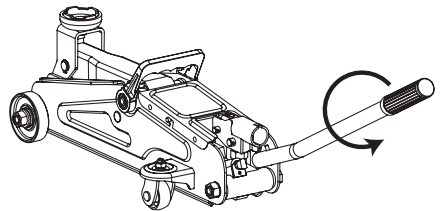

3. Remove cover plate.

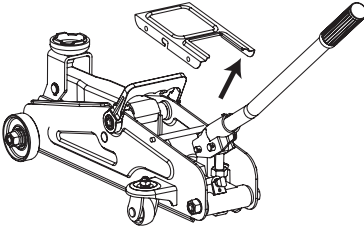

4. Remove the oil plug.

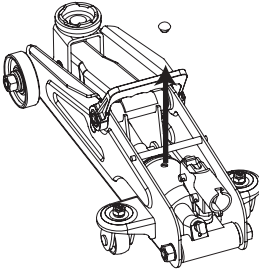

5. Turn the jack upside down to drain old oil from the oil fill hole.

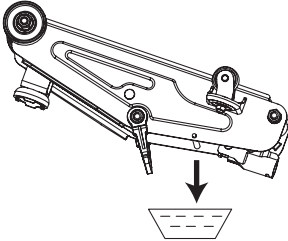

6. Position the jack on level ground and keep saddle in the lowered position. Fill the oil case until oil level is just beneath the lower rim. Keep dirt and other foreign materials clear when pouring.

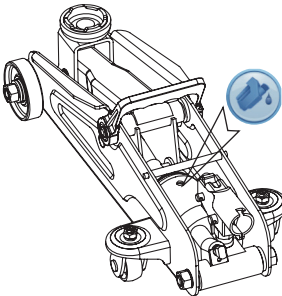

7. Replace oil plug.

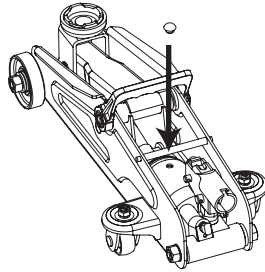

8. Replace the cover plate and perform the Air Purge Procedure.

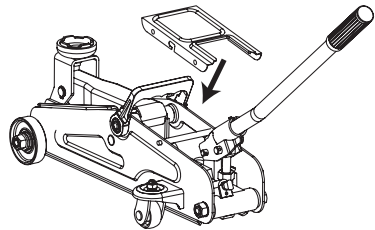

▲ ADDITIONAL WARNINGS:

- DO NOT USE MOTOR OIL IN THE JACK.
- ONLY USE ANTI-FOAMING JACK OIL.
- ALWAYS USE A GOOD GRADE HYDRAULIC JACK OIL.
- DO NOT USE HYDRAULIC BRAKE FLUID, ALCOHOL, GLYCERINE, DETERGENT, MOTOR OIL OR DIRTY OIL.
- USE OF A NON-RECOMMENDED FLUID CAN CAUSE DAMAGE TO A JACK.
- AVOID MIXING DIFFERENT TYPES OF FLUID AND NEVER USE BRAKE FLUID, TURBINE OIL, TRANSMISSION FLUID, MOTOR OIL OR GLYCERIN. IMPROPER FLUID CAN CAUSE PREMATURE FAILURE OF THE JACK AND THE POTENTIAL FOR SUDDEN AND IMMEDIATE LOSS OF LOAD.
- DISPOSE OF HYDRAULIC FLUID IN ACCORDANCE WITH LOCAL REGULATIONS.

ADDITIONAL LUBRICATION:

1. Periodically check the pump piston and ram for signs of rust or corrosion. As needed thoroughly wipe with a clean non-scratching oil soluble cloth. NEVER USE SANDPAPER OR ABRASIVE MATERIAL ON THESE SURFACES!
2. When not in use, store the jack with pump piston and ram fully retracted.

TROUBLESHOOTING

JACK WILL NOT LIFT LOAD	JACK WILL NOT HOLD LOAD	JACK WILL NOT LOWER	POOR JACK LIFTING	WILL NOT LIFT TO FULL EXTENSION	CAUSES AND SOLUTIONS
X	X		X		Release valve is not completely closed (Turn handle clockwise).
X					Weight Capacity Exceeded.
X			X		Air is in the hydraulics. Purge air from system.
X	X		X	X	Low oil level. Add oil as required.
		X			Oil reservoir is overfilled. Drain excessive oil. Lubricate moving parts.
		X			Jack is binding or foreign obstruction
X	X		X		Power unit malfunctioning. Replace the power unit.

Safe Operating Temperature is between 40°F – 105°F (4°C - 41°C)

WARRANTY NOTICE

This service jack is covered under a 1-year limited warranty when used as recommended. Only those items listed with a Part # are available for purchase. For assistance with the operation or the availability of replacement parts, contact our Parts and Warranty Department at 1-888-44-TORIN (1-888-448-6746). Please have available a copy of your receipt, the model number of the product, serial number, and specific details regarding your question.

Not all equipment components are available for replacement; illustrations provided are a convenient reference of location and position in the assembly sequence.

The manufacturer reserves the rights to make design changes and or improvements to product lines and manuals without notice.

WARRANTY INFORMATION

We want to know If you have any concerns with our products. If so, please call toll-free for Immediate assistance. For additional web customer support help inquiries visit the Customer Service section at: <http://www.torin-usa.com>.

TORIN ONE YEAR LIMITED WARRANTY

Torin Inc.® has been producing quality automotive repair and maintenance products since 1968. All products sold are felt to be of the highest quality and are covered by the following warranty:

With proof of purchase for a period of one year from the date of that purchase, the manufacturer will repair or replace, at its discretion, without charge, any of its products or parts thereof which fail due to a defect in material or workmanship. This warranty does not cover damage or defects caused by improper use, careless use or abuse of the equipment. This warranty does not cover parts normally considered to wear out or be consumed in the normal operation of the equipment. Except where such limitations and exclusions are specifically prohibited by applicable law, (1) THE CONSUMERS SOLE AND EXCLUSIVE REMEDY SHALL BE THE REPAIR OR REPLACEMENT OF DEFECTIVE PRODUCTS AS DESCRIBED ABOVE, and (2) THE MANUFACTURER SHALL NOT BE LIABLE FOR ANY CONSEQUENTIAL OR INCIDENTAL DAMAGE OR LOSS WHATSOEVER, and (3) THE DURATION OF ANY AND ALL EXPRESSED AND IMPLIED WARRANTIES, INCLUDING, WITHOUT LIMITATION, ANY WARRANTIES OF MERCHANTABILITY AND FITNESS FOR A PARTICULAR PURPOSE, IS LIMITED TO A PERIOD OF ONE YEAR FROM DATE OF PURCHASE. Product alteration in any manner by anyone other than us, with the sole exception of alterations made pursuant to product instructions and in a workman like manner. You acknowledge and agree that any use of the product for any purpose other than the specified use(s) stated in the product instructions is at Your own risk.

Always check for damaged or worn out parts before using any product. Broken parts will affect the equipment operation. Replace or repair damaged or worn parts immediately. Do not modify the product in any way. Unauthorized modification may impair the function and/or safety and could affect the life of the equipment. There are specific applications for which products are designed and tested during production. Manufacturer provided warranted items are not authorized to be repaired by anyone other than the manufacturer or manufacture approved repair person. Distributor does not have authorization to amend these statements. You acknowledge and agree that any modification of the product for any purpose other than manufacturer completed repairs is at your own risk. Before using this product, read the owner's manual completely and familiarize yourself thoroughly with the product and the hazards associated with its improper use.

IMPORTANT: BEFORE FIRST USE on any Lift verify that a daily inspection has been completed and that all components are in the proper working order.

This limited warranty gives you specific legal rights, and you also may have other rights, which vary from state to state. Some states do not allow limitations or exclusions on implied warranties or incidental or consequential damages, so the above limitations may not apply to You. This limited warranty is governed by the laws of the State of California, without regard to rules pertaining to conflicts of law. The state courts located in San Bernardino County, California shall have exclusive jurisdiction for any disputes relating to this warranty.

Manufacturer reserves the rights to make design changes and or improvements to this product lines and manual without notice. We at Torin have taken every effort to ensure complete and accurate instructions have been included in this manual. However, possible product updates, revisions and or changes may have occurred since this printing. Torin Inc. reserves the right to change specifications without incurring any obligation for equipment previously or subsequently sold. Not responsible for typographical errors. Alternately Customer Service can be reached through www.torin-usa.com or via email at info@torin-usa.com.

Not all equipment components are available for replacement, but are illustrated as a convenient reference of location and position in the assembly sequence. Contact Customer Service for equivalent component. When you contact us, please have your Product's Model number, Serial Number and Description ready so that we may help you efficiently. This information can be found on a sticker on the product.

For any warranty support or if your Torin® equipment is not functioning properly contact Torin® Customer Service directly by telephone at 1-888-44-TORIN (1-888-448-6746)

8:00am – 5:00pm Pacific Time, Monday – Friday

www.torin-usa.com

Made in China



Contact Torin® Customer Service directly by telephone at:
1-888-44-TORIN (1-888-448-6746)
8:00am – 5:00pm Pacific Time, Monday – Friday

Communiquez directement avec le Service à la clientèle Torin® au:
1-888-44-TORIN (1-888-448-6746)
De 8 heures à 17 heures, heure du Pacifique, du lundi au vendredi

Comuníquese conel Servicio de Atención al Cliente de Torin® directamente por teléfono al:
1-888-44-TORIN (1-888-448-6746)
De lunes a viernes de 8:00 a. m. a 5 p. m. hora del Pacifico

Torin Inc.
4355 E. Brickell Street Ontario, CA USA
www.torin-usa.com
Made in China - Fabriqué en Chine - Hecho en China

