

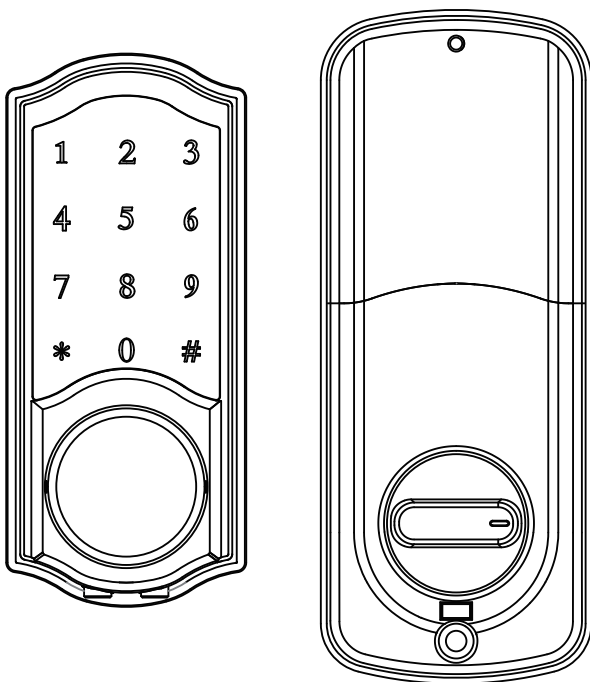

Smart Lock Manual

Electronic Keypad Deadbolt Lock



AM01

PREFACE

Please read this manual before installing.
Any question, please contact our customer service.

WARNING:

This Manufacturer advises that no lock can provide complete security by itself.

This lock may be defeated by forcible or technical means, or evaded by entry elsewhere on the property.

No lock can substitute for caution, awareness of your environment, and common sense.

In order to enhance security and reduce risk, you should consult a qualified locksmith or other security professional.

Please Note:

L/R side door has different install method, please follow the tips in video.

Or you could search on YouTube: SMONET Lock Installation Video

Warranty & After-sale Service:

We provide one year warranty and free life-time tech support.

Any question please feel free to contact us:

Toll Free(US):+18889886072

Toll Free(CA):+18557077879

(Available after 6:00 PM at PST if need)

E-mail(US & CA): smonetus@hotmail.com

Wechat: 602625520

DIRECTORY

INTRODUCTION	01
Product Specifications	01
Package	02
Performance	03
INSTALLATION MANUAL	04
Tools Needed	04
Installation Step	04
SMART INSTRUCTION	12
Pairing Lock to Phone App	12
TT LOCK App Operating	13
MATCH the Wi-Fi GATEWAY to the APPLICATION	17
MATCH the TTLOCK APP to the ALEXA APP	18
MATCH the SMART WATCH to the SMART LOCK	20
OPERATION INSTRUCTIONS	21
Setting Admin Passcode	21
Lock/Unlock	22
Battery Power Runs Out	23
Anti-theft Alarm Prompt	23
Reset Button	23

INTRODUCTION

Product Specifications

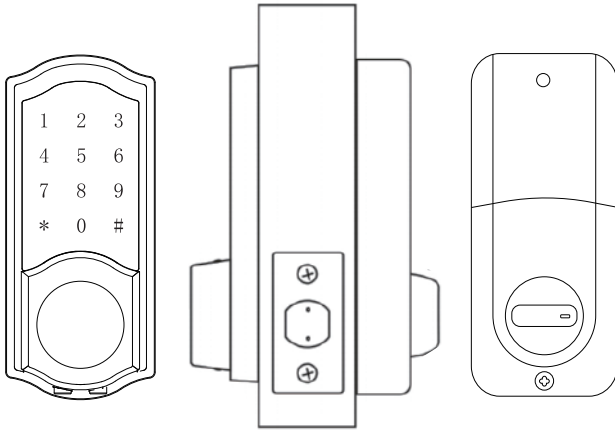

Item No.	S110BBL
Material	Zinc Alloy
Weight	2.86LB
Communication mode	Bluetooth 4.0ble
Unlocking way	Bluetooth, Code, Mechanical key
Support System	Android 4.3 / IOS 7.0 above
Unlock time	≈ 1.5 sec
Power supply	4pcs AA batteries
Static current	≤30uA
Working current	≤200mA

Package

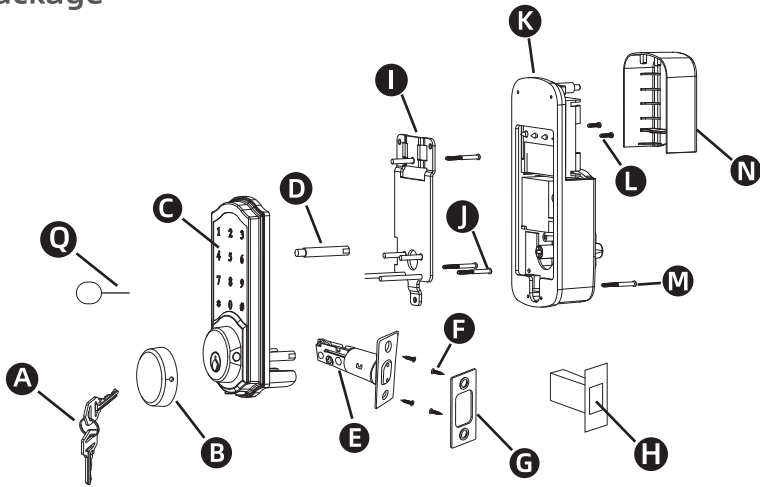

Part	Description	Quantity
A	Key	2
B	Keyhole Cover	1
C	Keypad	1
D	Double-screw Bolt	2
E	Latch	1
F	Wood Screws	4
G	Strike Plate	1
H	Box Striking Plate	1
I	Inside Mounting Plate	1
J	Flat Screw	4
K	Receiver Module	1
L	Short Flat Screw	3
M	Longest Flat Screw	1
N	Battery Cover	2
O	Size Reference Card	2
P	Drill Bit	1
Q	Needle	1

Performance

1.Smarter and Safer

Smart Lock Front Door set out to provide extra home security with keyless codes, Bluetooth unlock, anti-peep password and auto lock (5-200s) to keep your house safe and sound.

2.Real Time Record

Through Keyless Door Locks for Homes APP, you could check the unlocking records and incorrect password records from the Admin account in real time. And you'll have comfort in knowing your door's status.

3.Fast Sharing and Convenient

With Smart Digital Door Locks for Homes, You can share code with friends and guests valid for a few weeks, hours, or minutes, and revoke them whenever you need to. Never worry about lost, stolen or copied keys again.

4.Easily Install and Smart Reminder

Just a screwdriver and a easy-to-follow instruction to easily install Door Locks with Keypads. And when in low battery, Keypad Door Lock Deadbolt Set will alarm and could be temporary charged by a 9V battery.

INSTALLATION MANUAL

Note: Install and test lock with door open to avoid being locked out

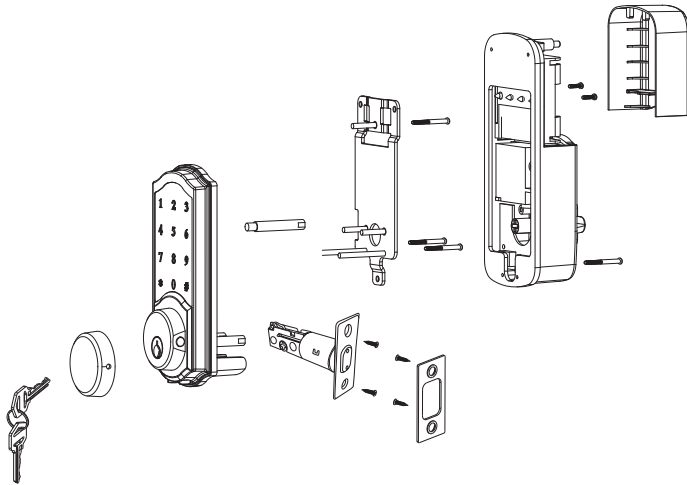

Tools Needed

Phillips Screwdriver Tape Measure Pencil Other Chiseling Tools

Installation Step

1. Adjusting Latch Length

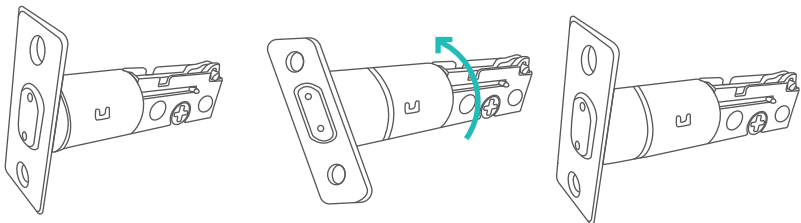

Note: When performing this operation, please take protective measures and be careful of the metal edge not to injure yourself.

Hold the right part of the lock tongue with your right hand and turn the left iron piece counter clockwise (about 15 degrees) with your left hand.

When the rectangular position of the 2-3/8" (60mm) tick mark changes from convex to concave (as shown), slowly extend the locking latch, and then turn clockwise the inside of the locking latch back to the rectangular position of 2-3/4" (70mm) scale.

2. Check Door Dimensions

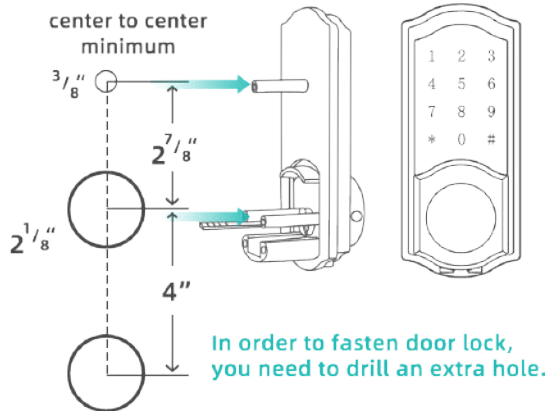
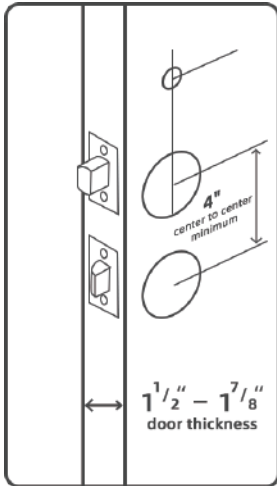

1. Backset Determination

Backset is a distance from door edge to center of hole on door face.

2. Hole's Diameters

Using the marks as guide to drill holes

Φ3/8"(10mm)----Fasten Smart door lock

Φ2-1/8"(54mm)

3. Door Thickness

The door thickness within 1-1/2" to 1-7/8" (38mm-48mm) are all suitable for the keypad deadbolt handle set.

3.Install Lock

1)Install Latch

Note:Need to keep this way up when inserting the latch.

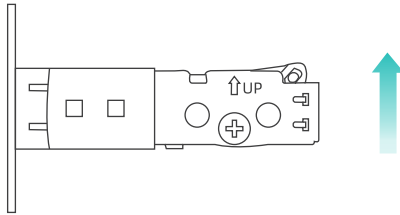

Insert the latch and ensure it is parallel to the door face.

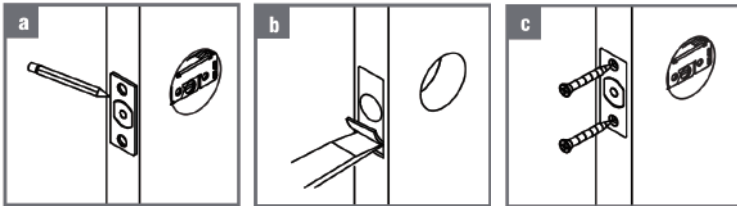

A.Mark the outline of the faceplate ,then take out the latch.

B.Chisel 1mm-2mm deep along the outline to allow the faceplate to be aligned with the door edge.

C.Insert the latch into the door ,use 2 wood screws to secure latch.

2)Install Plate

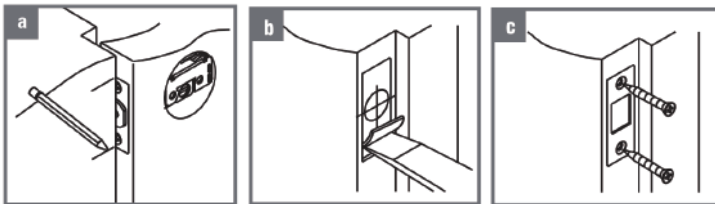

A.Identify the center of plate: Close the door to lay the latch bolt against the door frame.
Mark the the outline of the plate onto door jamb.

B.Drill 25mm deep at intersection of horizontal and vertical line of plate.

C.Insert the plate into the door jamb and secure it with two screws.

Chisel 1mm-2mm deep along the plate outline to allow the plate to be aligned with the door frame.

C.Insert the plastic lock groove and the strike plate into door jamb tighten with wood screws.

3)Install Keypad

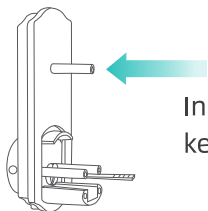

Install double-screw bolt into keypad inner plate.

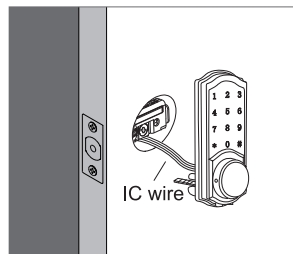

Place IC wire, latch link bar and double-screws through the holes on the deadbolt, as the picture on the right shows.

Note: IC wire should be placed under latch. After installing the front pad, roll the handle spindle to test if it could work with deadbolt or not. If could not, take out the front pad and roll the latch link bar around 90 degree and try to install again until it could work with the deadbolt.

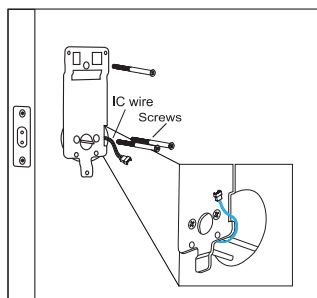
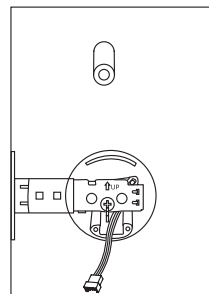

Pass the IC wire and the latch link bar to mounting plate.

Use 1 flat screw to secure with the keypad double-screw bolt.

Use 2 flat screw connect mounting plate with latch.

Note: Please place the IC line as shown in the figure to avoid the lock latch out of control.

4)Identify Door Handing

The door is "Left-handle" if the hinges are on the left side of the door.

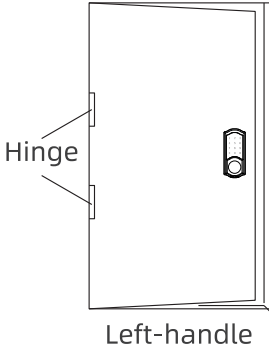

Whereas the door is "Right-handle" if the hinges are one the right side of the door.

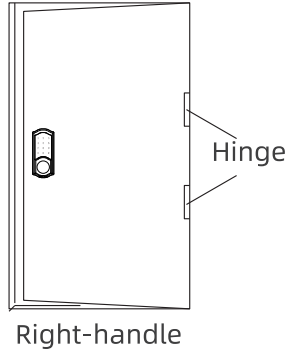

5)Adjust Thumb Turn Piece

Rotate the thumb turn piece to "Horizontal Direction" for Left-handle (open into room) door when in unlock status.

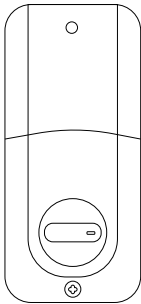

Rotate the thumb turn piece to "Vertical Direction" for Right-handle (open into room) door when in unlock status.

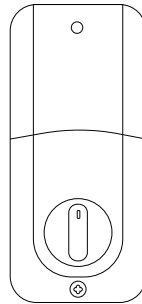

6) Adjust the Toggle Button of the Cover

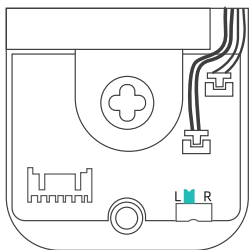

To install the lock for left side handling, ensure the toggle button on the back cover assembly is set to "L".

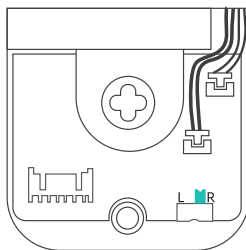

To install the lock for right side handling, ensure the toggle button on the back cover assembly is set to "R".

7) Install Receiver Module

Remove the battery cover (Press the spring button with the sharp object and push the cover up first then push it up)

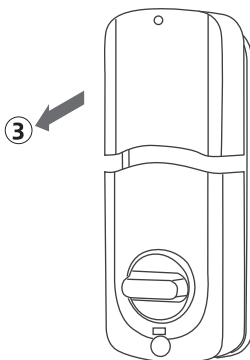
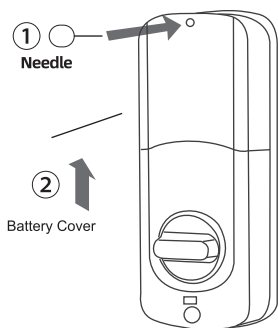

Connect IC wire to the white port carefully.

Note: Ensure the thumb turn piece and the toggle button of the cover in right way.

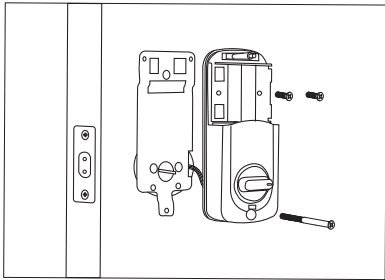
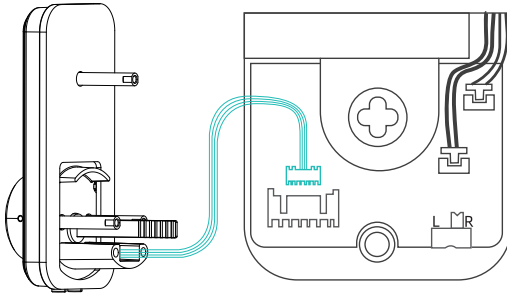

Use 2 short flat screw tighten the receiver module inner battery groove. Longest flat screw connect the receiver module with door.

8) Insert Battery and Install Back Battery Cover

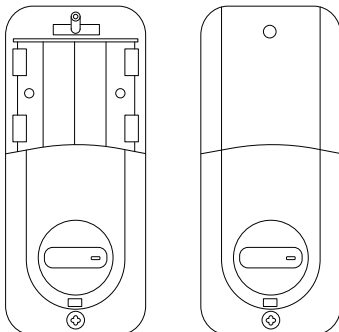

Insert 4pc (AA) 1.5V Alkaline batteries and slide the battery cover back onto the receiver module.

Remarks:

(1) Alkaline batteries are recommend in order to stabilize the power supply,if you don't use alkaline, battery performance will be reduced greatly.

(2) All settings will be retain in the memory even if the batteries are complete dead .If batteries are complete dead, using 9V backup battery to unlock the door.

SMART INSTRUCTION

Pairing Lock to Phone App

1. Download the App " TTLock"

Android Mobile Phone--Search "TTLock" from Google Play.

Apple Mobile Phone--please search "TTLock" from App Store.



2. Register and Login the Account

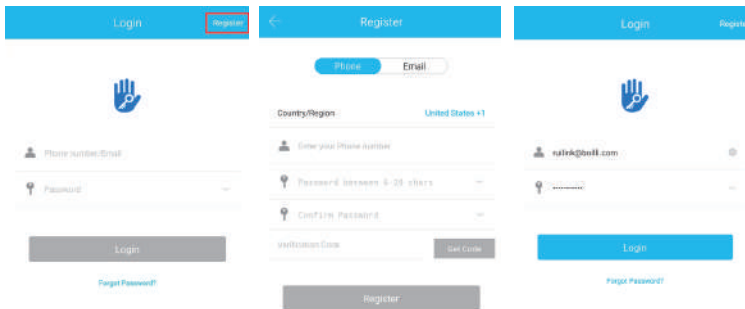

3. Match the Lock to the Application

When matching, follow the prompt steps of the program, you need to touch the screen after installing the lock and installing the battery, match the blue icon lock , and set the name for the lock.

Note: If the smart lock is in a non-addable state, Take out batteries to power off the lock about 5 seconds. Then, power on and long press manual button about 10 seconds. Once hearing beep beep sound, the lock is reset successfully.

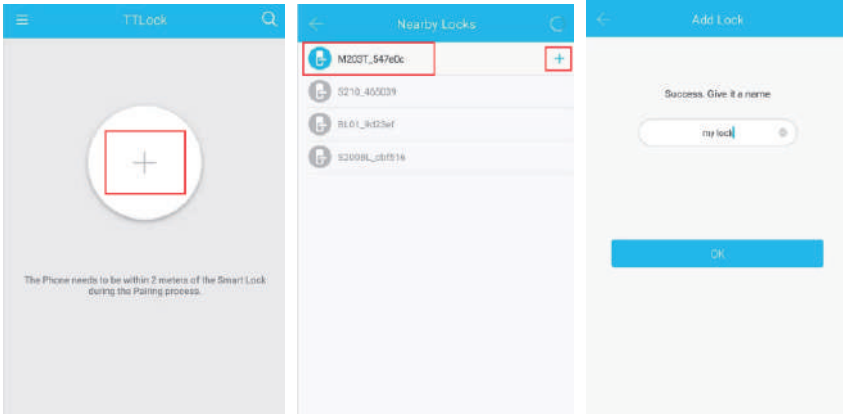

TT LOCK App Operating

1.Account Information Change

When logging in "TTLock" App, you need set up an account contain account password.

Each account can be added with multiple smart device locks for management.

Once the smart lock is added, it will become the admin account for the lock.

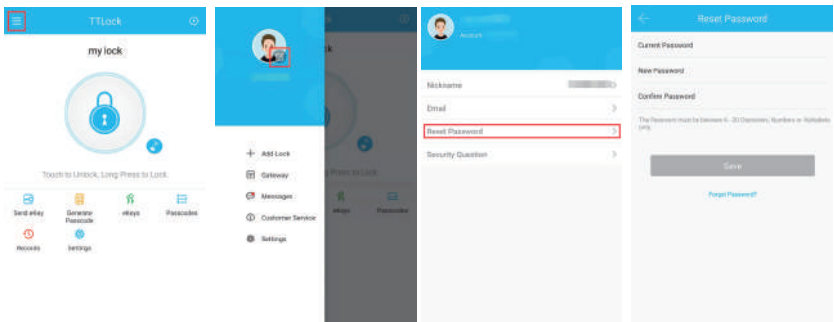

2.Lock/Unlock

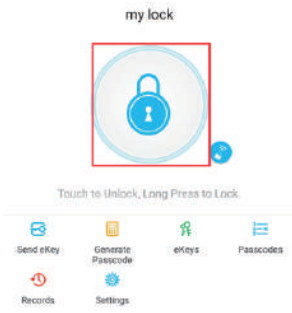

Press for unlock, long press for lock. It requires your smart phone and Bluetooth lock to be within a certain range.

Note: If you want remote control, you need to connect to the Gateway.

3.Send ekey

You can add another account on the app. This way your family can also control the Bluetooth lock via the app. Support authorized users to Limit time, Permanent, One-time, Recurring control smart lock.

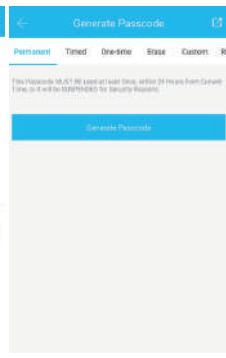
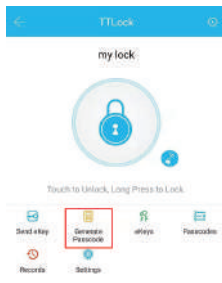
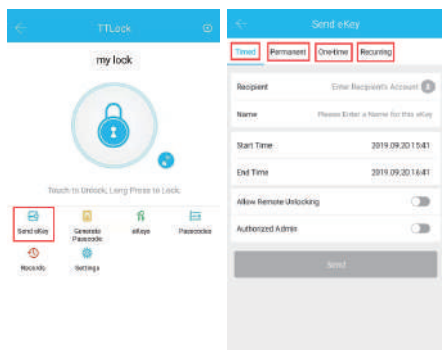

4.Generate Passcode

Generate or customize the passcode of the Bluetooth lock. Generate or customize permanent, one-time, time-limited, recurring passcode.

Note: Generate the passcode to clear the passcode that Bluetooth lock stored by "Erase". Once used, in addition to the admin passcode, other passcode will be cleared.

5.ekeys

Manage the authorized accounts in "Send eKey". Admin can clear eKey, reset eKey, send eKey, etc.

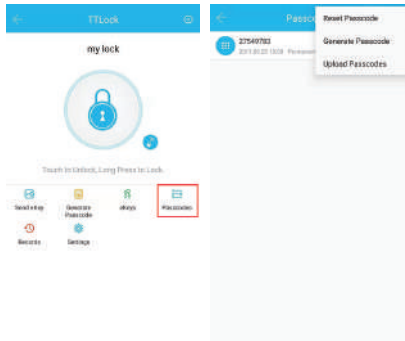
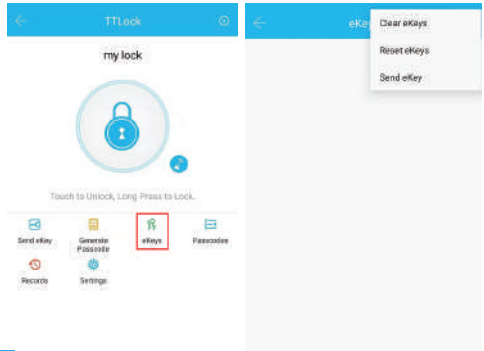

6.Passcodes

It records all passwords stored by the Bluetooth lock you had set. In addition, it can also reset, generate, upload passwords.

7.Records

It records the time and manner of the smart lock when someone opening or closing. Manage your Bluetooth lock safely and efficiently.

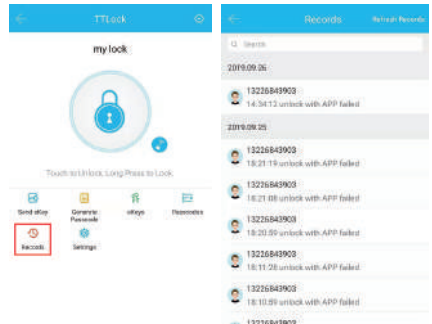

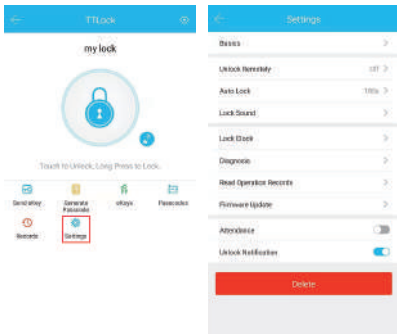

8.Settings

It have the function about the Bluetooth lock function setting, lock information setting, remote unlocking, auto-off time, lock sound, time proofread, record reading, etc.

You can find the information about the lock such as battery power, admin passcode.

Note:The admin passcode will not be cleared when erase passcode.

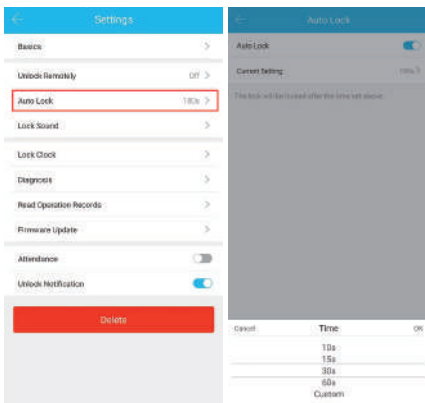
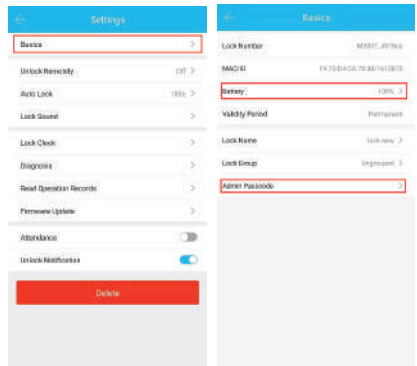

If you forget to lock your door often, you could to set “Auto Lock” .

Set the time for automatic locking in your needs, so you don't have to worry about security accidents due to being unlock.

9.Remote Control

Remote control support needs an extra additional Wi-Fi Gateway. Match the gateway, smart phone, app then the smart lock can support remote control lock.

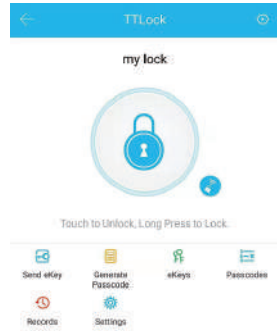
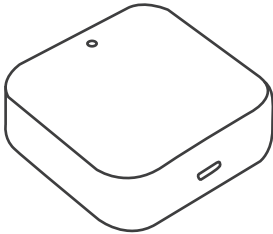

MATCH the Wi-Fi GATEWAY to the APPLICATION

Remote Control and Aleax would support after matching the Wi-Fi Gateway.

Click the button in the upper left corner of the page and enter relevant information as prompted to add a gateway to your account.

Note: When the smart phone app matches the smart lock or the gateway, it is necessary to enable Bluetooth and Wi-Fi. It can be successfully matched when your smart phone is close to the lock and the Gateway.

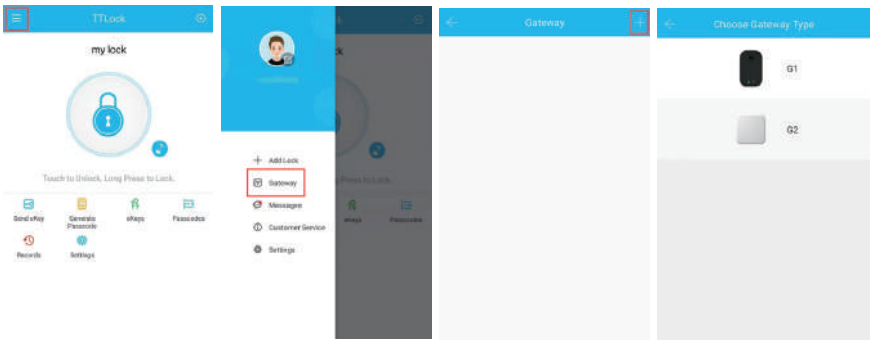

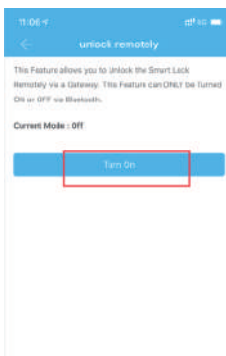
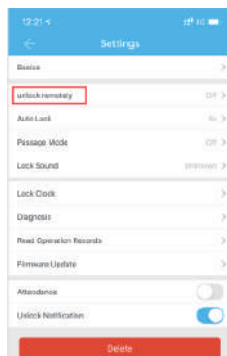
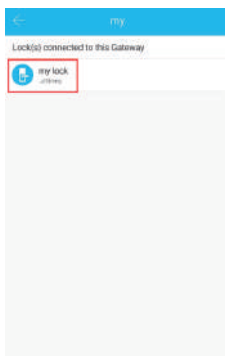
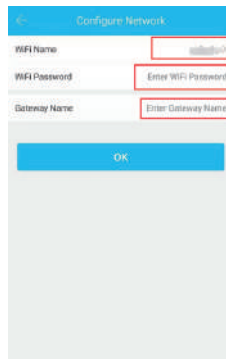
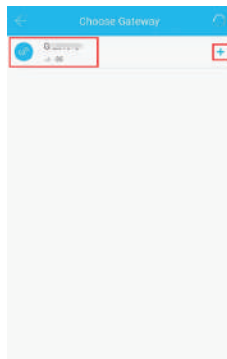

MATCH the TTLOCK APP to the ALEXA APP

After setting up to the gateway, authorize the TTLock app in the Alexa app and log in to the TTLock account to enable remote unlock and voice remote unlock.

Select "Skill & Games", input "TTLock" in the search bar, click "ENABLE TO USE". And input TTLock account and password to finish the authorization.

Note: If shows "Invalid Account and Password", please add "+1" at front of the account.

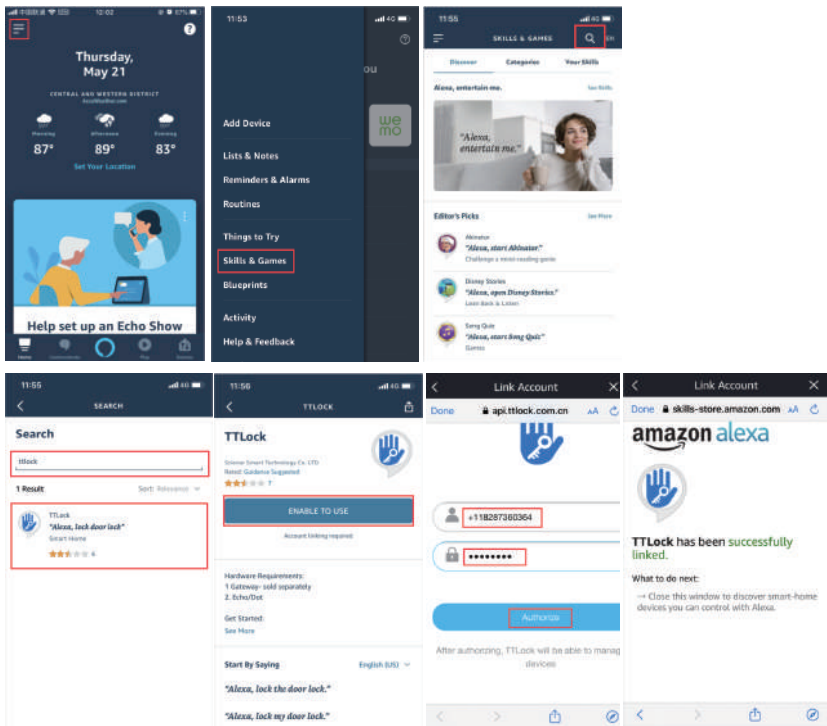

Press locks option, choose the lock you paired. Click the icon in the upper right corner and slide the icon button of “unlock by app” and “unlock by voice” .

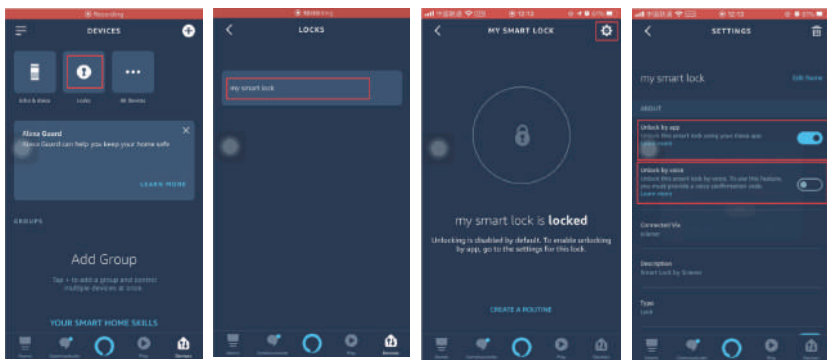

MATCH the SMART WATCH to the SMART LOCK

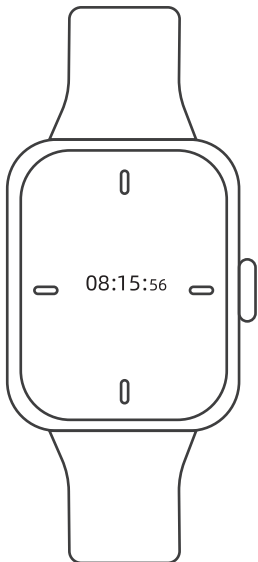

Apple watch
Android watch

Support Smart Watch (Apple watch or Android watch) lock/unlock.

It is supported that smart watch match to smart phone.

If the watch is connected to the phone, but it cannot search the "TTLock" App. Try to log in to the home page at your phone app, to refresh, and then check in the watch.

If all settings are normal but can't lock/unlock.

Opening the "TTLock" App in your phone to check if the key is in a normal state.

Note:All the operations, your watch and mobile phone require a certain range, the mobile phone network and Blue-tooth need to remain in a normal state.

OPERATION INSTRUCTIONS

keep the door opened while programming to avoid being locking out accidentally.

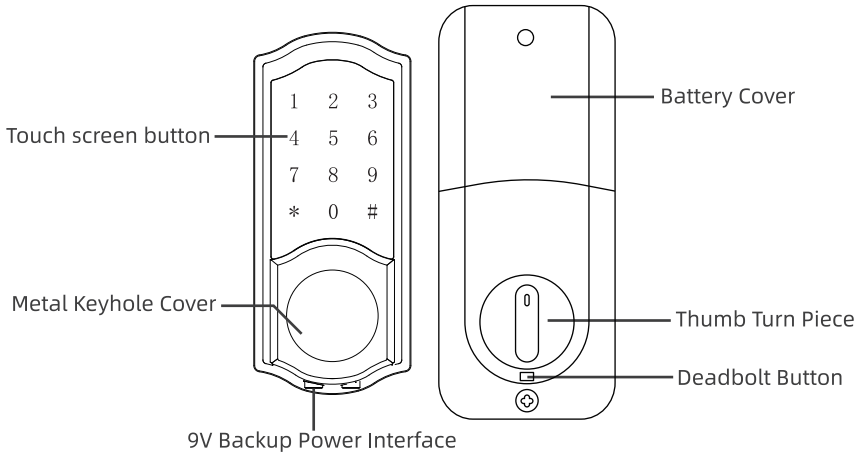

Setting Admin Passcode

The admin passcode can generated/set up after matching the " TTLock" app. When not added to the phone, enter "*12#123456#Custom Admin Passcode#Confirm Passcode#" in Keypad.

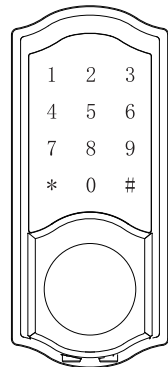

Lock/Unlock

Via Key: The package contains two keys that can be used directly through the keyhole.

Via Keypad: Enter the passcode then press “#” to unlock. Long press “#” and hold 2s for lock.

Via APP: Touch to unlock, long press to lock. It supports at a certain distance between smart phone and lock

Note: Remote control support need to matching with Wi-Fi Gateway.

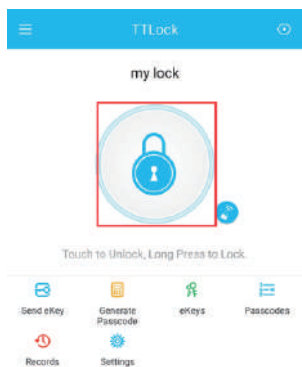

Rotate turn piece to unlock/lock from inside.

First time to long press deadbolt, when it make a clear sound

“DiDi” , all the passcode even app control couldn't unlock outside except admin passcode.

When long press it again until make another sound “Di” , all are back to normal , the smart lock in works.

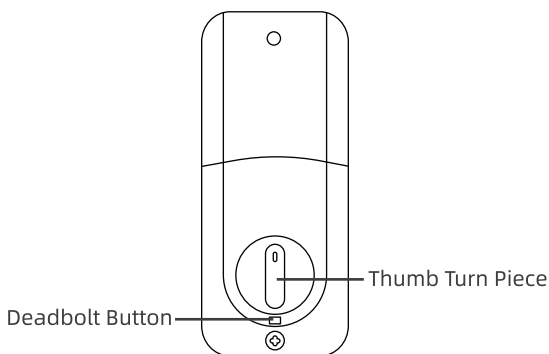

Battery Power Runs Out

The smart lock sounds an alarm when the battery is low.

If needed use 9V backup battery to interface then unlock.

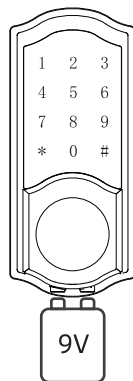

Anti-theft Alarm Prompt

Anti-theft Alarm Prompt

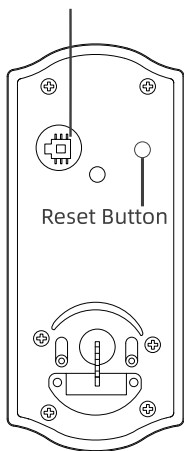

The smart lock has an anti-theft alarm function.

Turn off the anti-theft alarm:

Enter "*32# (admin password) #0#" on the keypad.

Turn on the anti-theft alarm:

Enter "*32# (admin password) #1#" on the keypad.

Note: Keep the alarm button on the front panel always pressed during install, otherwise it will always be beeping while installing battery.

Reset Button

If the smart lock is in a non-addable state (the name is gray on the APP or cannot find), please press and hold the reset button and try to connect again.

Note: This button is in the front Keypad panel. Please power on the smart lock when reset.

Take out batteries to power off the lock about 5 seconds. Then, power on and long press manual button about 10 seconds. Once hearing beep beep sound, the lock is reset successfully.

